

版次 (REV)	变更编号 (ECN NO)	说明 (DESCRIPTION)	日期 (DATE)	核准 (APP)
X1		初版发行		

Ordering information

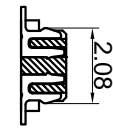
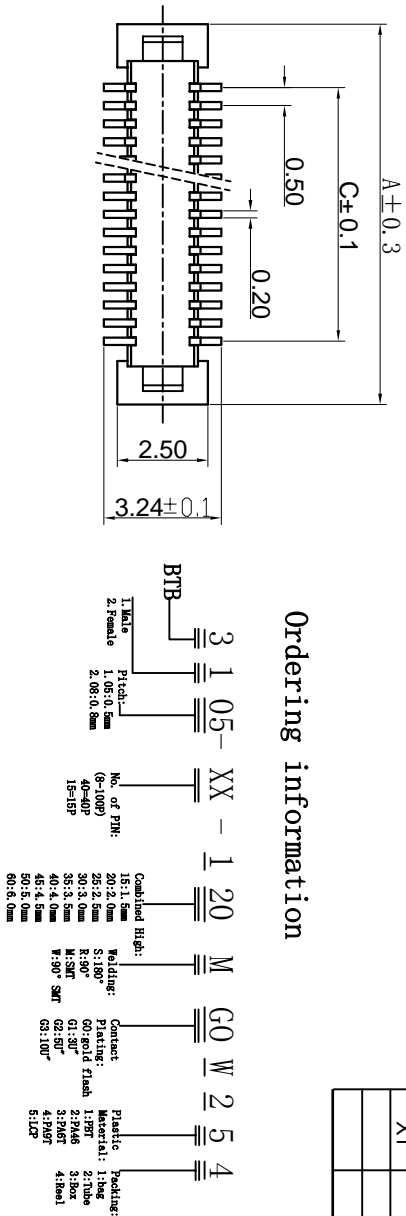

Electrical

Voltage: 50 V AC(rms)/DC
 Current: 0.5A AC(rms)/DC
 Contact Resistance: 40 mΩ max (initial)
 Dielectric Withstanding Voltage: 200 V AC/rms
 Insulation Resistance: 500 MΩ min
 Operating Temp: -25° C ~ +85° C

PCB 寸法

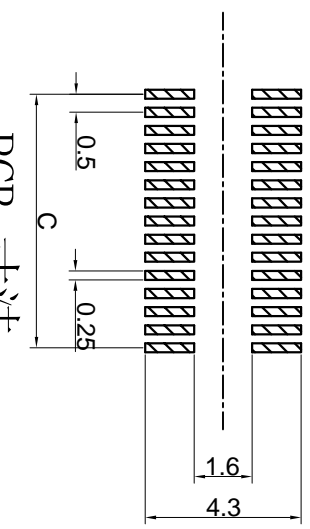

P 数	尺寸			P 数	尺寸		
	A	B	C		A	B	C
004	5.00	2.90	1.50	033	19.50	17.40	16.00
005	5.50	3.40	2.00	034	20.00	17.90	16.50
006	6.00	3.90	2.50	035	20.50	18.40	17.00
007	6.50	4.40	3.00	036	21.00	18.90	17.50
008	7.00	4.90	3.50	037	21.50	19.40	18.00
009	7.50	5.40	4.00	038	22.00	19.90	18.50
010	8.00	5.90	4.50	039	22.50	20.40	19.00
011	8.50	6.40	5.00	040	23.00	20.90	19.50
012	9.00	6.90	5.50	041	23.50	21.40	20.00
013	9.50	7.40	6.00	042	24.00	21.90	20.50
014	10.00	7.90	6.50	043	24.50	22.40	21.00
015	10.50	8.40	7.00	044	25.00	22.90	21.50
016	11.00	8.90	7.50	045	25.50	23.40	22.00
017	11.50	9.40	8.00	046	26.00	23.90	22.50
018	12.00	9.90	8.50	047	26.50	24.40	23.00
019	12.50	10.40	9.00	048	27.00	24.90	23.50
020	13.00	10.90	9.50	049	27.50	25.40	24.00
021	13.50	11.40	10.00	050	28.00	25.90	24.50
022	14.00	11.90	10.50	051	28.50	26.40	25.00
023	14.50	12.40	11.00	052	29.00	26.90	25.50
024	15.00	12.90	11.50	053	29.50	27.40	26.00
025	15.50	13.40	12.00	054	30.00	27.90	26.50
026	16.00	13.90	12.50	055	30.50	28.40	27.00
027	16.50	14.40	13.00				
028	17.00	14.90	13.50				
029	17.50	15.40	14.00				
030	18.00	15.90	14.50				
031	18.50	16.40	15.00				
032	19.00	16.90	15.50				

使用类别 (EXTEND USE)	品名 (TITLE)	
BTB0.5 1.5-2.5公座无柱	BTB0.5 1.5-2.5公座无柱 客户图面	
尺寸公差	单位 (UNIT)	图号 (DWG NO):
DIMENTION ±0.30 .0 ±0.20 .00 ±0.10 .000 ±0.05	mm	2001A0
角度公差	原材料 (MATERIAL)	料号 (P/N):
ANGLES .0 ±2° .00 ±1°	数量 (QTY)	3105-XX125MGOW254
	表面处理 (FINISHED)	页数 (SHEET)
		1/1
	审核 (CHK)	比例 (SCALE)
	数量 (QTY)	1:1
	表面处理 (FINISHED)	
	绘图 (DRAW)	
	尹彩艳	
	2010/5/19	

版次 (REV)	变更编号 (ECN NO)	说明 (DESCRIPTION)	日期 (DATE)	核准 (APP)
X1		初版发行		

Ordering information

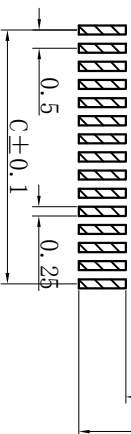
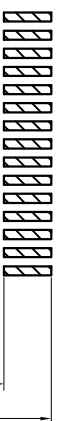
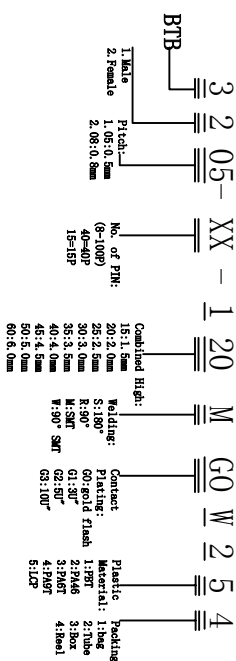
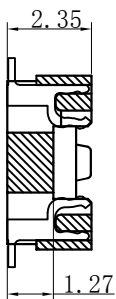
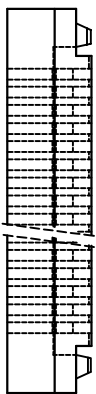
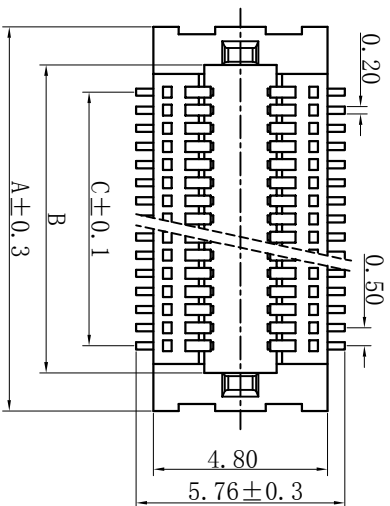

PCB 寸法

Electrical

Voltage: 50 V AC(rms)/DC
 Current: 0.5A AC(rms)/DC
 Contact Resistance: 40 mΩmax (initial)
 Dielectric Withstanding Voltage: 200 V AC/rms
 Insulation Resistance: 500 MΩ min
 Operating Temp: -25° C ~ +85° C

装配

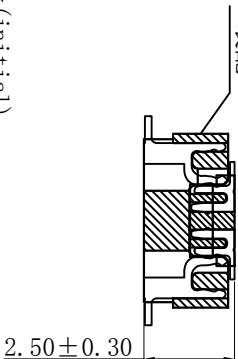

P 数	尺寸			P 数	尺寸		
	A	B	C		A	B	C
004	5.10	3.00	1.50	033	19.60	17.50	16.00
005	5.60	3.50	2.00	034	20.10	18.00	16.50
006	6.10	4.00	2.50	035	20.60	18.50	17.00
007	6.60	4.50	3.00	036	21.10	19.00	17.50
008	7.10	5.00	3.50	037	21.60	19.50	18.00
009	7.60	5.50	4.00	038	22.1	20.00	18.50
010	8.10	6.00	4.50	039	22.60	20.50	19.00
011	8.60	6.50	5.00	040	23.10	21.00	19.50
012	9.10	7.00	5.50	041	23.60	21.50	20.00
013	9.60	7.50	6.00	042	24.10	22.00	20.50
014	10.10	8.00	6.50	043	24.60	22.50	21.00
015	10.60	8.50	7.00	044	25.10	23.00	21.50
016	11.10	9.00	7.50	045	25.60	23.50	22.00
017	11.60	9.50	8.00	046	26.10	24.00	22.50
018	12.10	10.00	8.50	047	26.60	24.50	23.00
019	12.60	10.50	9.00	048	27.10	25.00	23.50
020	13.10	11.00	9.50	049	27.60	25.50	24.00
021	13.60	11.50	10.00	050	28.10	26.00	24.50
022	14.10	12.00	10.50	051	28.60	26.50	25.00
023	14.60	12.50	11.00	052	29.10	27.00	25.50
024	15.10	13.00	11.50	053	29.60	27.50	26.00
025	15.60	13.50	12.00	054	30.10	28.00	26.50
026	16.10	14.00	12.50	055	30.60	28.50	27.00
027	16.60	14.50	13.00				
028	17.10	15.00	13.50				
029	17.60	15.50	14.00				
030	18.10	16.00	14.50				
031	18.60	16.50	15.00				
032	19.10	17.00	15.50				

使用类别 (EXTEND USE)	品名 (TITLE)	图号 (DWG NO):
BTB0.5*2.5母座无柱	BTB0.5*2.5母座无柱	2008A0
尺寸公差	单位 (UNIT)	料号 (P/N):
DIMENTION ±0.30	mm	3205-XX125MGOW254
.0 ±0.20		页数 (SHEET) 1/1
.00 ±0.10		比例 (SCALE) 1:1
.000 ±0.05		
角度公差	数量 (QTY)	
ANGLES ±3°	表面处理 (FINISHED)	
.0 ±2°		
.00 ±1°		
原材料 (MATERIAL)	核准 (APP)	
数量 (QTY)	审核 (CID)	
表面处理 (FINISHED)	绘图 (DRW)	
	尹彩艳	2010/5/19

