

Specifications:
 Current Rating: 1.5 Amp
 Voltage Rating: 150V AC/DC
 Contact resistance: 20m Ohm Max
 Insulator resistance: 1000M ohm min.
 Withstanding Voltage: 500V AC/Minute
 Operating Temperature Range: -40° ~ +105° C
 Material And Finish
 Insulator: Polyester, (PBT U94V-0)
 Insulator Color: Black
 Contact: Brass
 Contact Plated: See Contact Plated Tab.

Ordering information

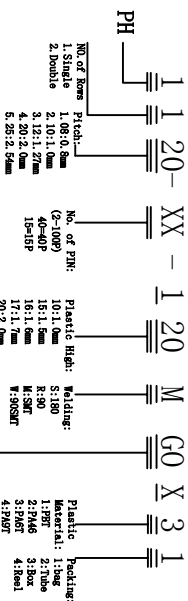

Gold Plated	Plastic Height	Waisting	Plastic Packaging
Gold Plated	10:1.1mm	S:180	1: 2000
Gold Plated	15:1.1mm	R:50	1: 1PBT
Gold Plated	17:1.1mm	W:3P46	2: 2P46
Gold Plated	20:2.54mm	3: 3P46	3: 3P46
Gold Plated	25:2.54mm	4: 3P46	4: 3P46
Gold Plated	25:2.54mm	5: 10P	5: 10P

Plastic Base

Type	可定制尺寸
H	1.5/2.0
PA	4.0
PB	2.8
PC	4.5



PCB LAYOUT



品名 (TITLE): PH2.0 1*NP SMT 立贴 系列图

绘图 (DRAWING) / 审核 (CHECK) / 标准 (APPROVED) / 日期 (DATE)

比例 (SCALE): 1:1

单位 (UNIT): MM

A4

页次 (SHEET): 10F1

RoHS Compliant

Customer Drawing

http://www.goxconn.com

修改记录(REVISION RECORD)

修改说明(DESCRIPTION)

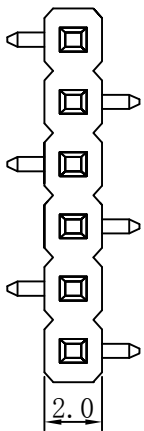

TYPE 1

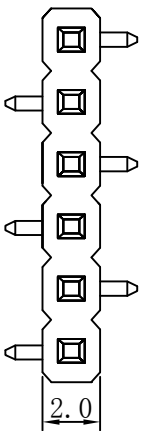

TYPE 2

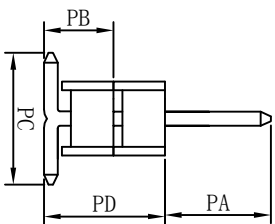
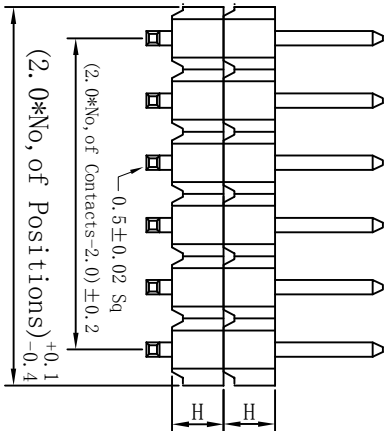

Specifications:

- Current Rating: 1.5 Amp
- Voltage Rating: 150V AC/DC
- Contact resistance: 20m Ohm Max
- Insulator resistance: 1000M ohm min.
- Withstanding Voltage: 500V AC/Minute
- Operating Temperature Range: -40° ~+105° C
- Material And Finish
- Insulator: Polyester, (PBT UL94V-0)
- Insulator Color: Black
- Contact: Brass
- Contact Plated: See Contact Plated Tab.

Ordering information

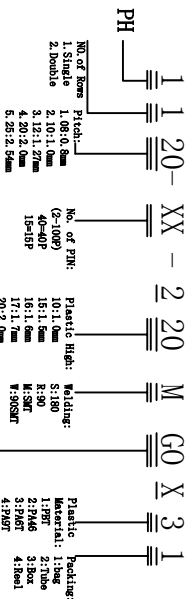

Solder Plating	Positional Tolerance	Solder	Pin Type
01	0.100	Sn62Pb38	TH 1000°
02	0.100	Sn62Pb38	TH 1000°
03	0.100	Sn62Pb38	TH 2000°
04	0.100	Sn62Pb38	TH 1500°
05	0.100	Sn62Pb38	TH 1000°
06	0.100	Sn62Pb38	TH 1000°
07	0.100	Sn62Pb38	TH 1000°
08	0.100	Sn62Pb38	TH 1000°
09	0.100	Sn62Pb38	TH 1000°

Plastic Base

Type 可定制尺寸

H 1.5/2.0

PA 4.0

PB 2.8

PD 4.8

PC 4.5

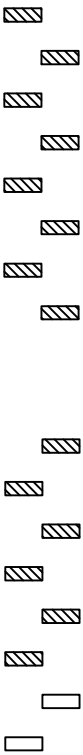

TYPE 1

TYPE 2

PCB LAYOUT



品名 (TITLE):

PH2.0 1*NP SMT 立贴 双塑 系列图

A4

线性 (LINER)	角度 (ANGLES)	未注公差 UNLESS OTHERWISE SPECIFIED TOLERANCE
x ± 0.20	x' ± 1'	
.xx ± 0.15	.xx' ± 15'	
.xxx ± 0.10	.xxx' ± 10'	

第三类垂直影 THIRD ANGLE PROJECTION	审核 (CHECK)	绘图 (DRAWING)	品名 (TITLE)
	审核 (CHECK)	绘图 (DRAWING)	PH2.0 1*NP SMT 立贴 双塑 系列图
第三类垂直影 THIRD ANGLE PROJECTION	审核 (CHECK)	绘图 (DRAWING)	品名 (TITLE)

日期 (DATE)	版本 (REV.)	图号 (DRAW NO.)	比例 (SCALE)	单位 (UNIT)	页码 (SHEET)	总页 (SHEET)
日期 (DATE)	版本 (REV.)	图号 (DRAW NO.)	比例 (SCALE)	单位 (UNIT)	页码 (SHEET)	总页 (SHEET)
	AO	1120-XX220MCOX-11	1:1	MM	10F1	